



AQUAFORCE[®]

30XW

Water-Cooled Liquid Chiller

Cooling capacity: 250~3467kW



Turn To The Experts

Carrier is a leading global provider of innovative HVAC, refrigeration, fire, security and building automation technologies.

Supported by the iconic Carrier name, the company's portfolio includes industry-leading brands such as Carrier, Kidde, Edwards, LenelS2 and Automated Logic.

Carrier's businesses enable modern life, delivering efficiency, safety, security, comfort, productivity and sustainability across a wide range of residential, commercial and industrial applications.



In 1998, Time magazine named Dr. Carrier one of its 20 most influential builders and titans of the 20th century.



Nomenclature

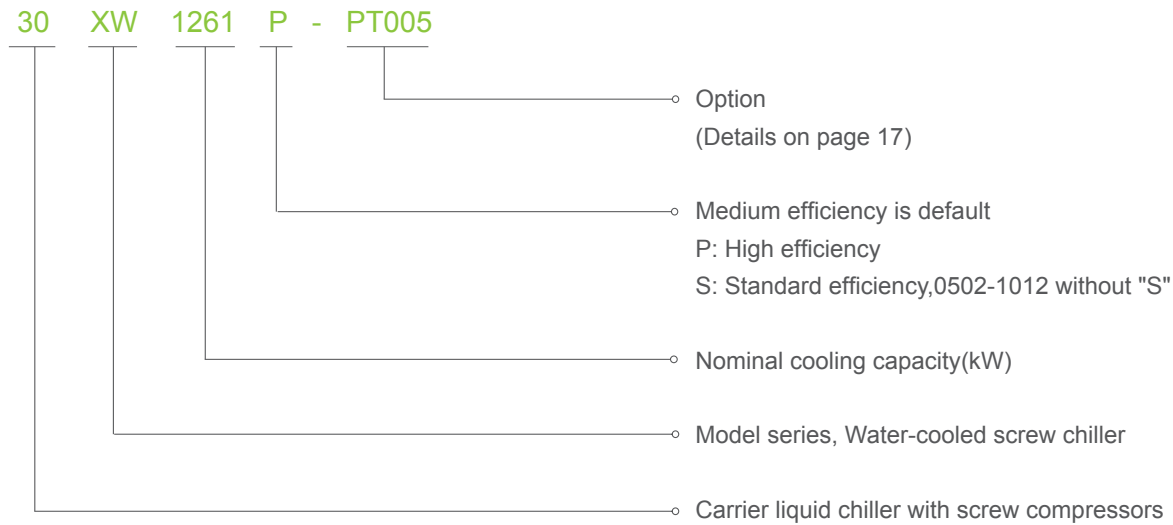

Operating Range

Cooling/Heating		
Evaporator	Minimum	Maximum
Entering temperature at start-up	-	35 °C
Leaving temperature during operation	3.3 °C*	20 °C
Entering/leaving temperature difference at full load	2.8 °C	11.1 °C
Condenser	Minimum	Maximum
Entering temperature at start-up	13 °C	-
Leaving temperature during operation	19 °C**	50 °C***
Entering/leaving temperature difference at full load	2.8 °C	11.1 °C

*If the leaving water temperature is below 3.3 °C, a frost protection solution must be used.

Please refer to option 05 and option 06 for application with low evaporator leaving water temperature (>-12 °C).

**If the temperature leaving the condenser is below 19 °C, a water flow control valve must be used at the condenser (two or three-way valve). Please refer to option 152 to ensure the correct condensing temperature.

***Please refer to option 150 for applications with high condenser leaving temperature (up to 63 °C). Refer to 30XW-S and 30XW0262/0312/0352/1012 standard chiller with condenser leaving temperature 48 °C. 30XW-P/S 1261-1601 with condenser leaving temperature 45 °C.

Note:
Ambient temperature: During storage and transport of the 30XW units the minimum and maximum permissible temperatures are -20 °C and 60 °C. These temperatures should be taken into consideration for transport by container.

Cooling Capacity

250~3467kW



All data over 200Tons in this catalogue is rated in accordance with AHRI Standard 550/590 and 551/591 as represented in the Packaged Chiller Builder Selection Program (E-Cat)

Features

- ✔ The Aquaforce liquid chillers are the premium solution for industrial and commercial applications where installers, consultants and building owners require optimal performances and maximum quality.
- ✔ The Aquaforce liquid chillers are designed to meet current and future compactness. They use the most reliable technologies available today:
 - Twin-rotor screw compressors with a variable capacity valve.
 - Single refrigerant R134a.
 - Carrier SmartView™ Control system.
 - Flooded heat exchangers that are mechanically cleanable.
- ✔ To meet to all environmental and economic requirements, the 30XW is available in three efficiency classes:
 - Standard efficiency 30XW-S units that offer excellent quality with superior cost advantage, designed to maximize savings, it's the cost-effective choice, suitable for comfort cooling of hotels, office and industrial settings.
 - Medium-efficiency 30XW units that offer an optimized balance of technical and economical aspects, while at the same time boasting superior energy efficiency.
 - High-efficiency 30XW-P units that offer unequalled energy efficiency to satisfy the most stringent demands of building owners wanting to reduce operating costs to the minimum.
- ✔ The 30XW Aquaforce range is also split into two versions:
 - 30XW for air conditioning and refrigeration applications.
 - 30XW Heating for heating applications.
- ✔ These two versions provide the following performances:
 - High heating temperature, allowing the 30XW Heating Aquaforce to supply water with a condenser leaving water temperature of +63°C (option 150A)
 - Low temperature, allowing the 30XW Aquaforce to operate with an evaporator leaving glycol temperature down to -6°C (option 5) or -12°C (option 6).

Premium full load and part load performance

- ✔ New twin-rotor screw compressor specifically designed for HFC-134a equipped with a high-efficiency motor and a variable capacity valve that permits exact matching of the cooling capacity to the load.
- ✔ Flooded multi-pipe evaporator and condenser for increased heat exchange efficiency. The evaporator has a low pressure drop-which results in reduced cost of water pump.
- ✔ Electronic expansion device permitting operation at a lower condensing pressure and improved utilization of the evaporator heat exchange surface (superheat control).
- ✔ Economizer system with electronic expansion device for increased cooling capacity (30XW-P).

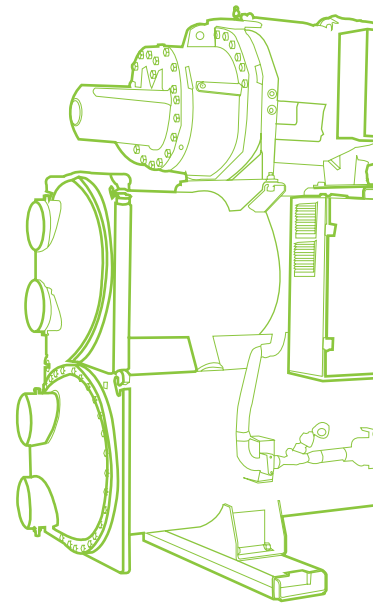
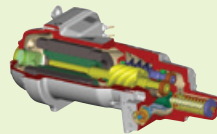

Absolute reliability

- ✔ Screw compressors
 - Industrial-type screw compressors with oversized bearings and motor cooled by suction gas.
 - Patented line-design screw rotors and microprocessor-based control to guarantee accurate meshing and enhance service life.
 - Reduced number of moving parts, with compressor rotors directly driven by the motor, to lower the failure rate and enhance reliability.
 - All compressor components are easily accessible on site minimizing down-time.
 - Protection increased by an electronic board.
- ✔ Evaporator
 - Electronic paddle-free flow switch. Auto-setting according to cooler size and fluid type.
- ✔ Auto-adaptive control.
 - Control algorithm prevents excessive compressor cycling (Carrier patent).
 - Automatic compressor unloading in case of abnormally high condensing pressure.
 - Control system has comprehensive protection during operation, such as oil temperature control, overvoltage and overcurrent protection, discharge temperature overheat protection, heat exchanger anti-freeze protection etc. in order to ensure chiller long time reliable operation.
- ✔ Exceptional endurance tests
 - Partnerships with specialized laboratories and use of limit simulation tools (finite element calculation) for the design of critical components.
 - Transport simulation test in the laboratory on a vibrating table and then on an endurance circuit.

Environmental care

- ✔ R134a refrigerant
 - Refrigerant of the HFC group with zero ozone depletion potential.
- ✔ Leak-tight refrigerant circuit
 - Reduction of leaks as no capillary tubes and are connections are used.
 - Verification of pressure transducers and temperature sensors without transferring refrigerant charge.
 - Discharge line shut-off valve and liquid line service valve for simplified maintenance.

Easy and fast installation

- ✔ Compact design
 - The 30XW units are designed to offer the most compact dimensions on the market.
 - With a width of approximately 1 m up to 1500 kW the units can pass through standard door openings and only require minimum floor space in the plant room.
- ✔ Simplified electrical connections
 - Main disconnect switch with high trip capacity.
 - Transformer to supply the integrated control circuit (400/24 V).
- ✔ Simplified hydronic connections
 - Victaulic connections on the evaporator and condenser.
 - Practical reference marks for entering and leaving water connections.
 - Possibility to reverse the heat exchanger water inlet and outlet at the factory.
- ✔ Fast commissioning
 - Systematic factory operation test before shipment.
 - Quick-test function for step-by-step verification of the instruments, expansion devices and compressors.

Smart Control

- ✔ New innovative Carrier SmartView™ control system combines intelligence with operating simplicity which providing more comfortable operation experience. The control constantly monitors all machine parameters and precisely manages the operation of compressors, electronic expansion devices and of the evaporator water pump for optimum energy efficiency.
- ✔ Ease-of-use
 - An intuitive and user-friendly interface, the concise and clear information is available in local languages.
 - Complete menu which can be customized for different users (end user, service personnel or Carrier engineers).
 - Graphically dynamic display of the operation parameters in real time.
 - Up to 10 languages for choice.
 - The DCT (Data Collection Tool) records the alarms history and automatically pushes alarm mail to simplify and facilitate service operations.
- ✔ Energy management
 - Internal time schedule clock: controls chiller on/off times and operation at a second set-point.
 - Set-point reset based on the return water temperature.
 - Carrier Smart Service (optional) provides value added customer service which enhanced data management and analysis will help achieve continuous optimization of the chiller and system operation.



Carrier SmartView™ Control System - Intelligent Colored Touch Screen

- ✦ 30XW chiller employs Carrier's most advanced Carrier SmartView™ controller that delivers distinct capabilities of controlling and monitoring the chiller operations.
- ✦ Equipped with high-resolution colorful touch screen, Carrier SmartView™ controller offers more user-friendly interface with intuitive graphical operational data in real time, adapts precisely the chiller capacity to building load and provides comprehensive protection.

Reliable Start - up and Operation

- ✦ Carrier SmartView™ controller offers password protection to avoid any unauthorized operation.
- ✦ When chiller starts, the controller will activate pre-start process to check parameters such as pressure, temperature, motor status, water flow etc.
- ✦ In addition to the function of monitoring the main operational parameters, trending function provide the visual dynamic parameter curves. The intelligent and dynamic algorithm ensures optimal, effective and reliable chiller operation.
- ✦ The control system provides following comprehensive protection, which guarantees steady chiller operation:
 - Overcurrent.
 - Discharge temperature overheat.
 - Motor temperature overheat.
 - Evaporator and condenser anti-freeze.
 - Low discharge superheat.

Effective Failure Diagnostic

- ✦ Carrier SmartView™ control system has more than 100 failure diagnostic function. Users can easily access chiller operation parameters via touch screen. If control system detects failure the alarm will be initiated and related code will be recorded in alarm menu. The alarm records, up to 50, can be automatically saved by control system. Carrier service technician can read and delete alarm records by Carrier service/PCDCT tools.
- ✦ The control system can automatically send out email alarm to customer or service technician.

Intelligent Remote Connection and Control

- Carrier SmartView™ control panel supports CCN, BACnet IP, Modbus TCP/IP and Modbus RTU protocols, with which chiller can seamlessly connect with the Building Automation System or the i-Vu®/WebCTRL control network. Moreover, LonWorks, J-Bus and BACnet MSTP is also supported with optional gateway.
- An industrial Internet intelligent protocol module WIFI dongle housed in electrical cabinet has the function of conversion and transmission of data and can connect the field chiller controllers through the wireless network. Chiller operational data can be transmitted to the remote server (Smart Service by Carrier) via wireless network, 4G, etc., so as to monitor chiller data and fault alarm.
- Carrier Smart Service (optional) based on “Big Data Processing” provides value added customer service such as online data management and analysis, daily and key performance reports, prognostics and preventative maintenance and graphic data trend. The enhanced data management and analysis will help achieve continuous optimization of the chiller and system operation.
- Carrier Smart Service changes how equipment is serviced and maintained. Carrier service technicians now utilize mobile devices with remote access to put real-time chiller data and service history in the palm of their hands. With advance notification of problems, technicians arrive at the jobsite more informed, which leads to faster problem resolution and reduced mean time to repair.

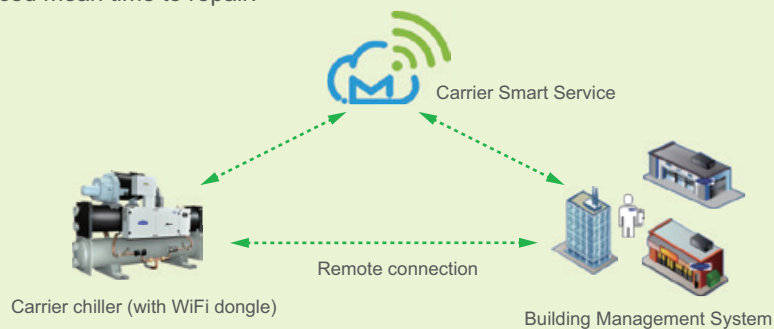

Main Page

- Control system main page operation and primary parameters monitored:

- Main page button
- Menu page button
- Log in/Language button
- Start-up/Stop page button
- Alarm menu button
- Setting point
- Chiller load percentage
- Condensing water pump status
- Chilled water pump status
- Condenser water inlet/outlet temperature
- Evaporator water inlet/outlet temperature

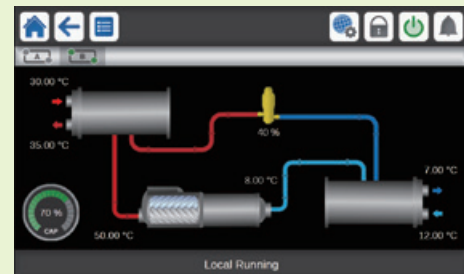

- Customer can easily read following primary information of chiller, components status and access to other interfaces from this page:

- Temperature/Pressure page
- Input/Output parameter page
- Water system parameter page
- Operation time
- Mode

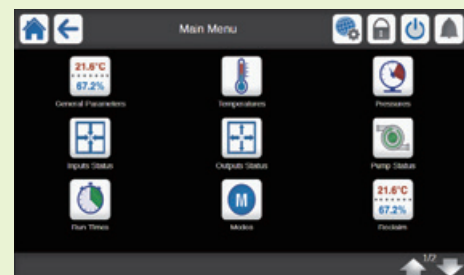

Performance data 30XW-P

Model			30XW-P																				
			0312P	0352P	0452P	0532P	0552P	0612P	0652P	0702P	0802P	0852P	0912P	1002P	1052P	1152P	1261P	1351P	1401P	1501P	1601P	1712P	1762P
Capacity		kW	303.5	366.3	448.5	536.1	571.8	640.1	675.8	729.7	785.0	852.3	897.5	974.0	1075.0	1147.0	1245.0	1340.0	1410.0	1489.0	1589.0	1747.0	1762.0
		USRT	86	104	128	152	163	182	192	208	223	242	255	277	306	326	354	381	401	423	452	497	501
COP		kW/kW	5.65	5.65	5.73	6.00	6.02	6.00	6.12	6.06	5.99	5.90	6.00	5.99	5.99	5.98	6.28	6.34	6.33	6.34	6.37	6.17	6.31
Evaporator	Flow rate	L/s	13.1	15.8	19.3	23.1	24.6	27.5	29.1	31.4	33.8	36.7	38.6	41.9	46.2	49.3	53.5	57.6	60.6	64.0	68.3	75.1	75.8
	Water Pressure drop	kPa	24.9	32.6	29.9	24.6	26.2	39.6	39.6	24.8	28.2	33.5	61.5	50.0	72.5	46.9	49.2	56.6	59.6	64.5	68.0	74.6	49.6
	Water connection	DN	125	125	125	150	150	200	200	200	200	200	200	200	200	200	200	200	200	200	200	250	250
Condenser	Flow rate	L/s	16.3	19.6	24.3	28.7	30.7	34.6	36.4	39.2	42.1	45.8	47.9	52.4	58.1	62.0	66.9	71.9	75.7	79.9	85.5	94.1	94.8
	Water Pressure drop	kPa	51.8	66.8	41.5	38.6	43.1	34.6	40.7	34.1	38.9	46.4	33.9	26.8	34.0	36.8	43.4	49.5	51.8	60.1	68.8	61.2	41.2
	Water connection	DN	125	125	125	150	150	200	200	200	200	200	200	200	200	200	200	200	200	200	200	250	250
Compressor	Circuit A	No.	1	1	1	1	1	1	1	1	1	1	1	1	1	1	1	1	1	1	1	1	1
	Circuit B	No.	-	-	-	-	-	-	-	-	-	-	-	1	1	1	-	-	-	-	-	1	1
	Min. capacity	%	15	15	15	15	15	15	15	15	15	15	15	8	8	8	20	20	20	20	15	8	8
Motor	Power	V-Ph-Hz	400-3-50																				
	Input power	kW	53.8	64.8	78.3	89.4	94.9	106.6	110.4	120.5	131.0	144.5	149.6	162.5	179.6	191.9	198.3	211.3	222.8	234.9	249.5	283.3	279.3
Refrigerant Charge			HFC-134a																				
	Circuit A	kg	78	78	100	135	135	176	176	200	200	200	233	115	115	130	365	365	365	365	365	187.5	250
	Circuit B	kg	-	-	-	-	-	-	-	-	-	-	-	125	125	140	-	-	-	-	-	187.5	250
Shipping weight*		kg	2301	2336	2866	3137	3177	4032	4012	4131	4149	4179	4260	5998	6067	6479	8114	8114	8165	8243	8333	9043	10348
Operation weight		kg	2083	2118	2600	2994	3025	3999	3979	4155	4173	4204	4299	6069	6112	6684	8230	8230	8280	8355	8443	9368	10948
Dimension	Length	mm	2740	2740	2763	3055	3055	3101	3080	3286	3286	3286	3142	4695	4695	4694	4515	4515	4515	4515	4515	4783	4809
	Width	mm	960	960	970	1008	1008	1135	1135	1135	1135	1135	1070	1070	1070	1070	1541	1541	1541	1541	1541	1985	2160
	Height	mm	1568	1568	1696	1743	1743	1950	1950	1949	1949	1949	2062	1947	1947	1998	2614	2614	2614	2614	2614	1520	1586

Operation condition: Evaporator leaving water temperature 6.7 C , water flow rate per capacity is 0.043 l/s-kW, fouling factor=0.018m²K/kW

Condenser entering water temperature 29.4 C , water flow rate per capacity is 0.054 l/s-kW, fouling factor=0.044m²K/kW

Above are recommended models. Carrier can offer more models and computer selections at required conditions. For details, please contact Carrier local agencies.

*The shipment weight is only base unit and wooden crating, excluding refrigerant and water inside.

Performance data 30XW

Model			30XW													
			0262	0312	0352	0412	0422	0452	0552	0622	0652	0702	0812	0852	0902	0922
Capacity		kW	249.5	303.6	366.9	424.0	452.7	468.9	540.2	621.0	662.3	715.3	784.5	826.1	852.4	890.6
		USRT	71	86	104	121	129	133	154	177	188	203	223	235	242	253
COP		kW/kW	5.28	5.31	5.30	5.29	5.29	5.45	5.59	5.60	5.51	5.61	5.60	5.52	5.83	5.66
Evaporator	Flow rate	L/s	10.7	13.1	15.8	18.2	19.5	20.2	23.2	26.7	28.5	30.8	33.7	35.5	36.7	38.3
	Water Pressure drop	kPa	16.4	22.8	29.5	34.5	36.7	27.6	36.1	34.0	33.7	38.3	39.9	48.3	54.3	62.2
	Water connection	DN	125	125	125	125	125	125	125	150	150	150	200	150	150	200
Condenser	Flow rate	L/s	13.5	16.4	19.6	22.7	24.4	25.1	28.9	33.3	35.4	38.1	41.8	44.4	45.7	47.8
	Water Pressure drop	kPa	32.4	43.4	54.6	34.7	36.4	36.4	46.1	47.0	51.8	54.3	29.6	36.2	42.2	50.6
	Water connection	DN	125	125	125	125	125	125	125	150	150	150	200	200	200	200
Compressor	Circuit A	No.	1	1	1	1	1	1	1	1	1	1	1	1	1	1
	Circuit B	No.	-	-	-	-	-	-	-	-	-	-	-	-	-	-
	Min. capacity	%	15	15	15	15	15	15	15	15	15	15	15	15	15	15
Motor	Power	V-Ph-Hz	400-3-50													
	Input power	kW	47.2	57.2	69.2	80.1	85.6	86.1	96.6	110.8	120.3	127.6	140.2	149.7	146.1	157.4
Refrigerant Charge			HFC-134a													
	Circuit A	kg	78	78	78	100	85	100	110	150	150	140	160	150	150	176
	Circuit B	kg	-	-	-	-	-	-	-	-	-	-	-	-	-	-
Shipping weight*		kg	2220	2281	2316	2692	2707	2846	2934	3637	3620	3647	3774	3808	3827	4012
Operation weight		kg	2002	2063	2098	2518	2518	2580	2684	3509	3486	3509	3688	3711	3923	3979
Dimension	Length	mm	2742	2742	2742	2746	2746	2746	2763	3084	3056	3084	2780	2780	3080	3080
	Width	mm	960	960	960	970	970	970	970	1119	1119	1119	1085	1085	1135	1135
	Height	mm	1568	1568	1568	1694	1694	1693	1693	1873	1849	1873	1950	1900	1900	1950

Operation condition: Evaporator leaving water temperature 6.7 C , water flow rate per capacity is 0.043 l/s-kW, fouling factor=0.018m²K/kW

Condenser entering water temperature 29.4 C , water flow rate per capacity is 0.054 l/s-kW, fouling factor=0.044m²K/kW

Above are recommended models. Carrier can offer more models and computer selections at required conditions. For details, please contact Carrier local agencies.

*The shipment weight is only base unit and wooden crating, excluding refrigerant and water inside.

Performance data 30XW

Model			30XW																
			1002	1052	1152	1261	1351	1401	1501	1601	1712	1762	2052	2302	2602	2902	3052	3302	3452
Capacity	kW		1003.0	1075.0	1135.0	1258.0	1327.0	1434.0	1498.0	1589.0	1709.0	1745.0	2037.0	2288.0	2594.0	2887.0	3046.0	3323.0	3467.0
	USRT		285	306	323	357	377	407	426	451	486	496	579	651	738	821	866	945	986
COP	kW/kW		5.60	5.64	5.64	5.88	5.88	5.93	5.93	5.90	5.75	5.80	5.83	5.83	5.87	5.90	5.83	5.83	5.83
Evaporator	Flow rate	L/s	43.1	46.2	48.8	54.1	57.1	61.6	64.4	68.3	73.5	75.0	87.6	98.4	111.6	124.1	131.0	142.9	149.1
	Water Pressure drop	kPa	55.9	68.0	54.4	36.9	39.5	52.5	51.7	58.3	80.8	61.4	68.7	67.3	66.9	72.2	79.8	82.9	85.4
	Water connection	DN	150	150	200	200	200	200	200	200	200	200	200	200	300	300	300	300	300
Condenser	Flow rate	L/s	54.0	58.0	61.4	67.7	71.4	76.6	80.1	85.1	91.9	93.3	109.2	123.9	140.5	156.0	164.7	179.1	186.7
	Water Pressure drop	kPa	33.2	43.4	41.2	38.6	40.5	56.8	52.1	62.7	61.9	58.3	58.3	52.6	60.4	52.4	58.6	62.0	66.6
	Water connection	DN	200	200	200	200	200	200	200	200	200	200	250	250	300	300	300	300	300
Compressor	Circuit A	No.	1	1	1	1	1	1	1	1	1	1/1	1/1	1/1	1/1	1/1	1/1	1/1	1/1
	Circuit B	No.	1	1	1	-	-	-	-	-	1	1	1/1	1/1	1/1	1/1	1/1	1/1	1/1
	Min. capacity	%	8	8	8	20	20	20	20	15	15	8	4	4	4	4	4	4	4
Motor	Power	V-Ph-Hz	400-3-50																
	Input power	kW	179.0	190.7	201.1	214.0	225.8	241.9	252.7	269.2	297.3	301.0	349.3	392.3	442.2	489.2	522.3	570.0	594.9
Refrigerant Charge			HFC-134a																
	Circuit A	kg	85	85	100	300	300	340	350	360	140	140	85/85	100/100	130/130	130/130	130/130	140/140	140/140
	Circuit B	kg	95	95	110	-	-	-	-	-	160	160	95/95	110/110	140/140	140/140	140/140	160/160	160/160
Shipping weight*	kg	5334	5349	5571	7312	7358	7704	7736	7831	9073	8994	10886	11454	14338	15494	15454	18667	18695	
Operation weight	kg	5255	5259	5553	7296	7341	7717	7781	7883	8953	8934	10870	11648	14842	16140	16100	18729	18757	
Dimension	Length	mm	4008	4029	4008	4088	4088	4488	4488	4488	4761	4787	4593	4602	5321	5359	5358	5422	5422
	Width	mm	1050	1050	1050	1526	1526	1526	1526	1524	1338	1258	2570	2570	2846	2932	2932	3066	3066
	Height	mm	1845	1845	1896	2563	2563	2563	2563	2563	2307	2307	1846	1896	2064	2064	2064	2307	2307

Operation condition: Evaporator leaving water temperature 6.7 C , water flow rate per capacity is 0.043 l/s-kW, fouling factor=0.018m²K/kW

Condenser entering water temperature 29.4 C , water flow rate per capacity is 0.054 l/s-kW, fouling factor=0.044m²K/kW

Above are recommended models. Carrier can offer more models and computer selections at required conditions. For details, please contact Carrier local agencies.

*The shipment weight is only base unit and wooden crating, excluding refrigerant and water inside.

Performance data 30XW-S

Model			30XW-S															
			0502	0612	0692	0802	0912	1012	1261S	1401S	1601S	1712S	1762S	2052S	2602S	2902S	3302S	3452S
Capacity		kW	520.2	610.2	697.4	772.1	881.4	1051.0	1229.0	1414.0	1571.0	1696.0	1727.0	2121.0	2478.0	2854.0	3185.0	3433.0
		USRT	148	174	198	220	251	299	350	402	447	482	491	603	705	812	906	976
COP		kW/kW	5.29	5.30	5.30	5.33	5.35	5.30	5.38	5.44	5.47	5.40	5.35	5.38	5.39	5.39	5.40	5.48
Evaporator	Flow rate	L/s	22.4	26.2	30.0	33.2	37.9	45.2	52.9	60.8	67.5	72.9	74.3	91.2	106.6	122.7	137.0	147.6
	Water Pressure drop	kPa	34.6	61.9	72.5	45.6	58.1	55.4	59.9	57.8	48.1	80.0	82.9	61.8	70.6	87.8	73.1	88.5
	Water connection	DN	125	150	150	150	150	150	200	200	200	200	200	200	200	300	300	300
Condenser	Flow rate	L/s	27.9	32.8	37.4	41.4	47.0	56.6	66.1	75.7	84.2	92.1	93.2	112.2	131.3	149.8	167.4	180.5
	Water Pressure drop	kPa	44.5	50.9	58.9	68.5	45.1	65.9	47.2	69.1	67.6	91.4	94.7	72.8	88.0	93.0	93.0	98.6
	Water connection	DN	125	150	150	150	200	200	200	200	200	200	200	250	250	300	300	300
Compressor	Circuit A	No.	1	1	1	1	1	1	1	1	1	1	1	1/1	1/1	1/1	1/1	1/1
	Circuit B	No.	-	-	-	-	-	1	-	-	-	1	1	1/1	1/1	1/1	1/1	1/1
	Min. capacity	%	15	15	15	15	15	8	20	20	15	8	8	4	4	4	4	4
Motor	Power	V-Ph-Hz	400-3-50															
	Input power	kW	98.3	115.1	131.5	144.9	164.8	198.2	228.3	260.0	287.2	314.0	323.1	394.3	459.9	529.8	590.1	626.4
Refrigerant Charge			HFC-134a															
	Circuit A	kg	100	140	140	150	155	85	272	285	320	130	130	85/85	110/110	115/115	130/130	130/130
	Circuit B	kg	-	-	-	-	-	95	-	-	-	140	140	95/95	115/115	120/120	140/140	140/140
Shipping weight*		kg	2883	3560	3560	3628	3845	5222	6705	7203	7312	7207	7207	10835	13153	14040	14370	14752
Operation weight		kg	2617	3426	3426	3493	3946	5109	6521	7101	7292	7379	7379	10740	13193	14354	14958	15340
Dimension	Length	mm	2746	3056	3056	3056	3080	4008	3947	4097	4097	4693	4693	4591	5251	5329	5356	5356
	Width	mm	970	1119	1119	1119	1135	1050	1526	1526	1524	1231	1231	2570	2761	2932	2932	2932
	Height	mm	1693	1849	1849	1849	1900	1846	2481	2563	2563	2064	2064	1846	2013	2013	2064	2064

Operation condition: Evaporator leaving water temperature 6.7 C , water flow rate per capacity is 0.043 l/s-kW, fouling factor=0.018m²K/kW

Condenser entering water temperature 29.4 C , water flow rate per capacity is 0.054 l/s-kW, fouling factor=0.044m²K/kW

Above are recommended models. Carrier can offer more models and computer selections at required conditions. For details, please contact Carrier local agencies.

*The shipment weight is only base unit and wooden crating, excluding refrigerant and water inside.

Electrical parameters 30XW-P (including option 81)

High efficiency units 30XW-P		0312P	0352P	0452P	0532P	0552P	0612P	0652P	0702P	0802P	0852P	0912P	1002P	1052P	1152P	1261P	1351P	1401P	1501P	1601P	1712P	1762P
Power circuit																						
Rated Voltage	V-ph-Hz	400-3-50																				
Voltage Range	V	360-440																				
Control circuit		24 V per internal transformateur																				
Nominal start-up current*																						
Circuit A	A	233	303	414	450	450	587	587	587	587	587	587	450	450	450	812	812	812	812	812	587	587
Circuit B	A	-	-	-	-	-	-	-	-	-	-	-	450	450	450	-	-	-	-	-	587	587
Option 81	A	-	-	-	-	-	-	-	-	-	-	-	594	612	612	-	-	-	-	-	819	819
Maximum start-up current **																						
Circuit A	A	233	303	414	450	450	587	587	587	587	587	587	450	450	450	812	812	812	812	812	587	587
Circuit B	A	-	-	-	-	-	-	-	-	-	-	-	450	450	450	-	-	-	-	-	587	587
Option 81	A	-	-	-	-	-	-	-	-	-	-	-	667	692	692	-	-	-	-	-	938	938
Cosine Phi																						
Nominal ***		0.86	0.86	0.86	0.87	0.87	0.89	0.89	0.89	0.89	0.90	0.90	0.86	0.87	0.87	0.91	0.91	0.91	0.91	0.91	0.90	0.90
Maximum †		0.89	0.89	0.89	0.90	0.90	0.90	0.90	0.90	0.91	0.92	0.92	0.89	0.90	0.90	0.92	0.92	0.92	0.92	0.92	0.92	0.92
Maximum power draw ††																						
Circuit A	kW	94	104	134	151	151	184	184	184	200	223	242	134	151	151	275	275	276	340	340	223	223
Circuit B	kW	-	-	-	-	-	-	-	-	-	-	-	134	134	151	-	-	-	-	-	223	223
Option 81	kW	-	-	-	-	-	-	-	-	-	-	-	268	285	302	-	-	-	-	-	446	446
Nominal current draw ***																						
Circuit A	A	97	116	144	162	162	193	193	193	214	232	266	144	162	162	317	339	354	376	398	232	232
Circuit B	A	-	-	-	-	-	-	-	-	-	-	-	144	144	162	-	-	-	-	-	232	232
Option 81	A	-	-	-	-	-	-	-	-	-	-	-	288	306	324	-	-	-	-	-	464	464
Maximum current draw (Un) ††																						
Circuit A	A	153	168	217	242	242	295	295	295	317	351	379	217	242	242	432	432	434	535	535	351	351
Circuit B	A	-	-	-	-	-	-	-	-	-	-	-	217	217	242	-	-	-	-	-	351	351
Option 81	A	-	-	-	-	-	-	-	-	-	-	-	434	459	484	-	-	-	-	-	702	702
Maximum current draw (Un -10%) †																						
Circuit A	A	162	178	230	260	260	304	304	304	340	358	402	230	260	260	475	475	477	588	588	358	358
Circuit B	A	-	-	-	-	-	-	-	-	-	-	-	230	230	260	-	-	-	-	-	358	358
Option 81	A	-	-	-	-	-	-	-	-	-	-	-	460	490	520	-	-	-	-	-	716	716

* Instantaneous start-up current (locked rotor current of the largest compressor + the rated load current of other smaller motors at nominal operating conditions)

Values obtained at operating condition: evaporator temperature entry/leave water = 12 C/7 C, condenser temperature entry/leave water = 30 C/35 C

** Instantaneous start-up current (locked rotor current of the largest compressor + the maximum load current of other smaller motors at maximum unit conditions)

Values obtained at operation with maximum unit power input

*** Values obtained at operating condition: evaporator temperature entry/leave water = 12 C/7 C, condenser temperature entry/leave water = 30 C/35 C

† Values obtained at operation with maximum unit power input

†† Values obtained at operation with maximum unit power input

Values given on the name plate

Electrical parameters 30XW (including option 81)

Medium efficiency units 30XW		0262	0312	0352	0412	0422	0452	0552	0622	0652	0702	0812	0852	0902	0922	
Power circuit																
Rated Voltage	V-ph -Hz	400-3-50														
Voltage Range	V	360-440														
Control circuit		24 V per internal transformateur														
Nominal start-up current*																
Circuit A	A	233	233	303	414	414	414	450	587	587	587	587	587	587	587	587
Circuit B	A	-	-	-	-	-	-	-	-	-	-	-	-	-	-	-
Option 81	A	-	-	-	-	-	-	-	-	-	-	-	-	-	-	-
Maximum start-up current **																
Circuit A	A	233	233	303	414	414	414	450	587	587	587	587	587	587	587	587
Circuit B	A	-	-	-	-	-	-	-	-	-	-	-	-	-	-	-
Option 81	A	-	-	-	-	-	-	-	-	-	-	-	-	-	-	-
Cosine Phi																
Nominal ***		0.86	0.86	0.86	0.86	0.86	0.86	0.87	0.88	0.88	0.89	0.90	0.90	0.90	0.90	
Maximum †		0.89	0.89	0.89	0.89	0.89	0.89	0.90	0.90	0.90	0.91	0.92	0.92	0.92	0.92	
Maximum power draw ††																
Circuit A	kW	80	94	104	134	134	134	151	184	184	200	223	223	223	242	
Circuit B	kW	-	-	-	-	-	-	-	-	-	-	-	-	-	-	
Option 81	kW	-	-	-	-	-	-	-	-	-	-	-	-	-	-	
Nominal current draw ***																
Circuit A	A	81	97	116	144	144	144	162	193	193	214	232	232	232	266	
Circuit B	A	-	-	-	-	-	-	-	-	-	-	-	-	-	-	
Option 81	A	-	-	-	-	-	-	-	-	-	-	-	-	-	-	
Maximum current draw (Un) ††																
Circuit A	A	130	153	168	217	217	217	242	295	295	317	351	351	351	379	
Circuit B	A	-	-	-	-	-	-	-	-	-	-	-	-	-	-	
Option 81	A	-	-	-	-	-	-	-	-	-	-	-	-	-	-	
Maximum current draw (Un -10%) †																
Circuit A	A	138	162	178	230	230	230	260	304	304	340	358	358	358	402	
Circuit B	A	-	-	-	-	-	-	-	-	-	-	-	-	-	-	
Option 81	A	-	-	-	-	-	-	-	-	-	-	-	-	-	-	

* Instantaneous start-up current (locked rotor current of the largest compressor + the rated load current of other smaller motors at nominal operating conditions)
Values obtained at operating condition: evaporator temperature entry/leave water = 12 C/7 C, condenser temperature entry/leave water = 30 C/35 C

** Instantaneous start-up current (locked rotor current of the largest compressor + the maximum load current of other smaller motors at maximum unit conditions)
Values obtained at operation with maximum unit power input

*** Values obtained at operating condition: evaporator temperature entry/leave water = 12 C/7 C, condenser temperature entry/leave water = 30 C/35 C

† Values obtained at operation with maximum unit power input

†† Values obtained at operation with maximum unit power input

Values given on the name plate

Electrical parameters 30XW (including option 81)

Standard efficiency units 30XW		1002	1052	1152	1261	1351	1401	1501	1601	1712	1762
Power circuit											
Rated Voltage	V-ph- Hz	400-3-50									
Voltage Range	V	360-440									
Control circuit		24 V per internal transformateur									
Nominal start-up current*											
Circuit A	A	450	450	414	812	812	812	812	812	587	587
Circuit B	A	450	450	414	-	-	-	-	-	587	587
Option 81	A	612	612	576	-	-	-	-	-	819	853
Maximum start-up current **											
Circuit A	A	450	450	414	812	812	812	812	812	587	587
Circuit B	A	450	450	414	-	-	-	-	-	587	587
Option 81	A	692	692	656	-	-	-	-	-	938	966
Cosine Phi											
Nominal ***		0.87	0.87	0.87	0.91	0.91	0.91	0.91	0.91	0.90	0.90
Maximum †		0.90	0.90	0.90	0.92	0.92	0.92	0.92	0.92	0.92	0.92
Maximum power draw ††											
Circuit A	kW	151	151	151	275	276	340	340	340	223	242
Circuit B	kW	134	151	151	-	-	-	-	-	223	223
Option 81	kW	285	302	302	-	-	-	-	-	446	465
Nominal current draw ***											
Circuit A	A	162	162	162	343	362	387	404	433	232	266
Circuit B	A	144	162	162	-	-	-	-	-	232	232
Option 81	A	306	324	324	-	-	-	-	-	464	498
Maximum current draw (Un) ††											
Circuit A	A	242	242	242	432	434	535	535	535	351	379
Circuit B	A	217	242	242	-	-	-	-	-	351	351
Option 81	A	459	484	484	-	-	-	-	-	702	730
Maximum current draw (Un -10%) †											
Circuit A	A	260	260	260	475	477	588	588	588	358	402
Circuit B	A	230	260	260	-	-	-	-	-	358	358
Option 81	A	490	520	520	-	-	-	-	-	716	760

* Instantaneous start-up current (locked rotor current of the largest compressor + the rated load current of other smaller motors at nominal operating conditions)

Values obtained at operating condition: evaporator temperature entry/leave water = 12 C/7 C, condenser temperature entry/leavewater = 30 C/35 C

** Instantaneous start-up current (locked rotor current of the largest compressor + the maximum load current of other smaller motors at maximum unit conditions)

Values obtained at operation with maximum unit power input

*** Values obtained at operating condition: evaporator temperature entry/leave water = 12 C/7 C, condenser temperature entry/leavewater = 30 C/35 C

† Values obtained at operation with maximum unit power input

†† Values obtained at operation with maximum unit power input

Values given on the name plate

Electrical parameters 30XW (including option 81)

Medium efficiency units 30XW		2052	2302	2602	2902	3052	3302	3452
Power circuit								
Rated Voltage	V-ph-Hz	400-3-50						
Voltage Range	V	360-440						
Control circuit		24 V per internal transformateur						
Nominal start-up current*								
Module1 Circuit A	A	414	414	587	587	587	587	587
Module1 Circuit B	A	414	414	414	587	587	587	587
Module1 Option 81	A	576	576	749	780	801	819	819
Module2 Circuit A	A	414	414	587	587	587	587	587
Module2 Circuit B	A	414	414	414	587	587	587	587
Module2 Option 81	A	576	576	749	780	801	819	819
Maximum start-up current **								
Module1 Circuit A	A	414	414	587	587	587	587	587
Module1 Circuit B	A	414	414	414	587	587	587	587
Module1 Option 81	A	656	656	829	882	904	938	938
Module2 Circuit A	A	414	414	587	587	587	587	587
Module2 Circuit B	A	414	414	414	587	587	587	587
Module2 Option 81	A	656	656	829	882	904	938	938
Cosine Phi								
Nominal ***		0.87	0.87	0.88	0.88	0.88	0.90	0.90
Maximum †		0.90	0.90	0.90	0.90	0.90	0.92	0.92
Maximum power draw ††								
Module1 Circuit A	kW	151	151	184	184	200	223	223
Module1 Circuit B	kW	134	151	151	184	184	202	223
Module1 Option 81	kW	285	302	335	368	384	425	446
Module2 Circuit A	kW	151	151	184	184	200	223	223
Module2 Circuit B	kW	134	151	151	184	184	202	223
Module2 Option 81	kW	285	302	335	368	384	425	446
Nominal current draw ***								
Module1 Circuit A	A	162	162	193	193	214	232	232
Module1 Circuit B	A	144	162	162	193	193	214	232
Module1 Option 81	A	306	324	355	386	407	446	464
Module2 Circuit A	A	162	162	193	193	214	232	232
Module2 Circuit B	A	144	162	162	193	193	214	232
Module2 Option 81	A	306	324	355	386	407	446	464
Maximum current draw (Un) ††								
Module1 Circuit A	A	242	242	295	295	317	351	351
Module1 Circuit B	A	217	242	242	295	295	317	351
Module1 Option 81	A	459	484	537	590	612	668	702
Module2 Circuit A	A	242	242	295	295	317	351	351
Module2 Circuit B	A	217	242	242	295	295	317	351
Module2 Option 81	A	459	484	537	590	612	668	702
Maximum current draw (Un -10%) †								
Module1 Circuit A	A	260	260	304	304	340	358	358
Module1 Circuit B	A	230	260	260	304	304	340	358
Module1 Option 81	A	490	520	564	608	644	698	716
Module2 Circuit A	A	260	260	304	304	340	358	358
Module2 Circuit B	A	230	260	260	304	304	340	358
Module2 Option 81	A	490	520	564	608	644	698	716

* Instantaneous start -up current (locked rotor current of the largest compressor + the rated load current of other smaller motors at nominal operating conditions)
Values obtained at operating condition: evaporator temperature entry/leave water = 12 C/7 C, condenser temperature entry/leave water = 30 C/35 C

** Instantaneous start -up current (locked rotor current of the largest compressor + the maximum load current of other smaller motors at maximum unit conditions)
Values obtained at operation with maximum unit power input

*** Values obtained at operating condition: evaporator temperature entry/leave water = 12 C/7 C, condenser temperature entry/leave water = 30 C/35 C

† Values obtained at operation with maximum unit power input

†† Values obtained at operation with maximum unit power input

Values given on the name plate

Electrical parameters 30XW-S (including option 81)

Standard efficiency units 30XW		0502	0612	0692	0802	0912	1012	1261S	1401S	1262S	1402S	1601S	1712S	1762S
Power circuit														
Rated Voltage	V-ph -Hz	400-3-50												
Voltage Range	V	360-440												
Control circuit		24 V per internal transformateur												
Nominal start-up current*														
Circuit A	A	414	587	587	587	587	414	812	812	587	587	812	587	587
Circuit B	A	-	-	-	-	-	414	-	-	414	587	-	587	587
Option 81	A	-	-	-	-	-	576	-	-	749	801	-	819	853
Maximum start-up current **														
Circuit A	A	414	587	587	587	587	414	812	812	587	587	812	587	587
Circuit B	A	-	-	-	-	-	414	-	-	414	587	-	587	587
Option 81	A	-	-	-	-	-	656	-	-	829	904	-	938	966
Cosine Phi														
Nominal ***		0.87	0.88	0.89	0.90	0.90	0.87	0.91	0.91	0.88	0.89	0.91	0.90	0.90
Maximum †		0.90	0.90	0.91	0.92	0.92	0.90	0.92	0.92	0.90	0.91	0.92	0.92	0.92
Maximum power draw ††														
Circuit A	kW	151	184	200	223	242	151	275	340	200	200	340	223	242
Circuit B	kW	-	-	-	-	-	151	-	-	151	200	-	223	223
Option 81	kW	-	-	-	-	-	302	-	-	351	400	-	446	465
Nominal current draw ***														
Circuit A	A	162	193	214	232	266	162	371	420	214	214	468	232	266
Circuit B	A	-	-	-	-	-	162	-	-	162	214	-	232	232
Option 81	A	-	-	-	-	-	324	-	-	376	428	-	464	498
Maximum current draw (Un) ††														
Circuit A	A	242	295	317	351	351	242	432	535	317	317	535	351	379
Circuit B	A	-	-	-	-	-	242	-	-	242	317	-	351	351
Option 81	A	-	-	-	-	-	484	-	-	559	634	-	702	730
Maximum current draw (Un -10%) †														
Circuit A	A	260	304	340	358	402	260	475	588	340	340	588	358	402
Circuit B	A	-	-	-	-	-	260	-	-	260	340	-	358	358
Option 81	A	-	-	-	-	-	520	-	-	600	680	-	716	760

* Instantaneous start-up current (locked rotor current of the largest compressor + the rated load current of other smaller motors at nominal operating conditions)

Values obtained at operating condition: evaporator temperature entry/leave water = 12 C/7 C, condenser temperature entry/leave water = 30 C/35 C

** Instantaneous start-up current (locked rotor current of the largest compressor + the maximum load current of other smaller motors at maximum unit conditions)

Values obtained at operation with maximum unit power input

*** Values obtained at operating condition: evaporator temperature entry/leave water = 12 C/7 C, condenser temperature entry/leave water = 30 C/35 C

† Values obtained at operation with maximum unit power input

†† Values obtained at operation with maximum unit power input

Values given on the name plate

Electrical parameters 30XW-S (including option 81)

mid efficiency units 30XW-S		2052S	2602S	2902S	3302S	3452S
Power circuit						
Rated Voltage	V-ph-Hz	400-3-50				
Voltage Range	V	360-440				
Control circuit						
24 V per internal transformateur						
Nominal start-up current*						
Module1 Circuit A	A	414	587	587	587	587
Module1 Circuit B	A	414	414	587	587	587
Module1 Option 81	A	576	749	801	819	819
Module2 Circuit A	A	414	587	587	587	587
Module2 Circuit B	A	414	414	587	587	587
Module2 Option 81	A	576	749	801	819	819
Maximum start-up current **						
Module1 Circuit A	A	414	587	587	587	587
Module1 Circuit B	A	414	414	587	587	587
Module1 Option 81	A	656	829	904	938	938
Module2 Circuit A	A	414	587	587	587	587
Module2 Circuit B	A	414	414	587	587	587
Module2 Option 81	A	656	829	904	938	938
Cosine Phi						
Nominal ***		0.87	0.88	0.89	0.90	0.90
Maximum †		0.90	0.90	0.91	0.92	0.92
Maximum power draw ††						
Module1 Circuit A	kW	151	200	200	223	223
Module1 Circuit B	kW	151	151	200	223	223
Module1 Option 81	kW	302	351	400	446	446
Module2 Circuit A	kW	151	200	200	223	223
Module2 Circuit B	kW	151	151	200	223	223
Module2 Option 81	kW	302	351	400	446	446
Nominal current draw ***						
Module1 Circuit A	A	162	214	214	232	232
Module1 Circuit B	A	162	162	214	232	232
Module1 Option 81	A	324	376	428	464	464
Module2 Circuit A	A	162	214	214	232	232
Module2 Circuit B	A	162	162	214	232	232
Module2 Option 81	A	324	376	428	464	464
Maximum current draw (Un) ††						
Module1 Circuit A	A	242	317	317	351	351
Module1 Circuit B	A	242	242	317	351	351
Module1 Option 81	A	484	559	634	702	702
Module2 Circuit A	A	242	317	317	351	351
Module2 Circuit B	A	242	242	317	351	351
Module2 Option 81	A	484	559	634	702	702
Maximum current draw (Un -10%) †						
Module1 Circuit A	A	260	340	340	358	358
Module1 Circuit B	A	260	260	340	358	358
Module1 Option 81	A	520	600	680	716	716
Module2 Circuit A	A	260	340	340	358	358
Module2 Circuit B	A	260	260	340	358	358
Module2 Option 81	A	520	600	680	716	716

* Instantaneous start -up current (locked rotor current of the largest compressor + the rated load current of other smaller motors at nominal operating conditions)
Values obtained at operating condition: evaporator temperature entry/leave water = 12 C/7 C, condenser temperature entry/leavewater = 30 C/35 C

** Instantaneous start -up current (locked rotor current of the largest compressor + the maximum load current of other smaller motors at maximum unit conditions)
Values obtained at operation with maximum unit power input

*** Values obtained at operating condition: evaporator temperature entry/leave water = 12 C/7 C, condenser temperature entry/leavewater = 30 C/35 C

† Values obtained at operation with maximum unit power input

†† Values obtained at operation with maximum unit power input

Values given on the name plate

Options & accessories

Options	NO	Description	Advantages	Use
Medium Brine	5	Brine application down to -6°C leaving fluid temperature	Covers specific application such as ice storage and industrial processes	30XW0262-3452/S (except 30XW-P and 30XW0502/0652/0802)
Low Brine	6	Brine application down to -12°C leaving fluid temperature * Use of air-cooled unit compressors * Increase size of electrical componts according to compressor motor electrical characteristics	Covers specific application such as ice storage and industrial processes	30XW1152/0552P/1002P
Single power connection	81	This option is required to allow to connect on single power supply line to one single location where std machine require two	Quick and easy installation	30XW1052-3452/-S 30XW1002P-1712P Each module of duplex with PT081
Closed Y-delta start	91	Closed Y-delta start built in conrtro box	Low the inrush current	30XW0652P/0702P/0802P/0912P
Evaporator & Condenser water pressue 1.6MPa	104	Reinforced evaporator & condenser for extension of the maximum water-side service pressure to 1.6MPa	Covers applications with a high water column(high buildings)	30XW0262-3452/S 30XW0312P-1712P
Evaporator & Condenser water pressue 2.1MPa	104A16	Reinforced evaporator & condenser for extension of the maximum water-side service pressure to 2.1MPa	Covers applications with a high water column(high buildings)	30XW0262-3452/S 30XW0312P-1712P
Evaporator with reversed water connection	107E	Evaporator with reversed water inlet/outlet	Simplification of the water piping	30XW0262-3452/S 30XW0312P-1712P
Condenser with reversed water connection	107C	Condenser with reversed water inlet/outlet	Simplification of the water piping	30XW0262-3452/S 30XW0312P-1712P
CCN to J bus gateway	148B	Two way protocol converter board between CCN and J-Bus for easy connection to BMS. Consist of: - Electronic board mounted in the unit electrical cabinet - Automatic configuration at start up	Easy connection by communication bus to a building management system	30XW0262-3452/S 30XW0312P-1712P
CCN to BAC Net/ Modbus gateway	148C	Two way protocol converter board between CCN and BAC Net/ Modbus for easy connection to BMS. Consist of: - Electronic board mounted in the unit electrical cabinet - Automatic configuration at start up	Easy connection by communication bus to a building management system	30XW0262-3452/S 30XW0312P-1712P
CCN to Lon work gateway	148D	Two way protocol converter board between CCN and Lon work for easy connection to BMS. Consist of: - Electronic board mounted in the unit electrical cabinet - Automatic configuration at start up	Easy connection by communication bus to a building management system	30XW0262-3452/S 30XW0312P-1712P
High condensing temperature unit (up to 63 C leaving condenser water temperature)	150	Increased condenser leaving water temperature up to 63 C . * Use of air-cooled unit compressors * Increase size of electrical componts according to compressor motor electrical characteristics	Allows applications with high condensing temperature(for heat reclaim or dry cooler applications)	30XW0262-3452/S 30XW0532P-1712P (except 0912P/1002P/0622/0812/0922/1762)
Condenser maxium leaving temperature limited to 45 C	150B	Control configuration to limit operation at 45°C maximum condenser leaving temperature	Avoids oversizing of the protection elements and the power cables	30XW0262-3452/S 30XW0532P-1712P
Heat pump (Max condenser leaving temp 63 C)	150A	Heat pump control logic to control condenser LWT * Use of air-cooled unit compressors * Increase size of electrical componts according to compressor motor electrical characteristics * Heat pump control logic * Condenser insulation	Allows heating applications with max condenser leaving temp 63 C	30XW0262-3452/S 30XW0532P-1712P
Condenser maxium leaving temperature 50°C	150E	Increase condenser LWT to 50°C	Allows application with high condensing temperature	30XW/-P/-S 1261-1601
Heat pump (Max condenser leaving temp 50 C)	150D	Heat pump control logic to control condenser LWT * Condenser insulation * Heat pump Control logic	Allows heating applications with max condenser leaving temp 50 C	30XW0262-3452/S 30XW0532P-1712P
Condenser water valve control (0-10V signal)	152	Output signal (0-10V) to control the condenser water inlet valve Consist of: - One 8DO+4AI/2AO Board - Connector for 3 way valve Note: Power supply for water valve is not included	Used for applications with cold water at the condenser inlet (well water). In this case the valve controls the water entering temperature to maintain an acceptable condensing pressure	30XW0262-3452/S 30XW0312P-1712P
Energy management module	156	Remote control module. Additional contacts for an extension of the unit control functions (without communication bus) Consist of: - Electrinoc board mounted in the unit electrical cabniet	Easy connection by wired connection to a building management system	30XW0262-3452/S 30XW0312P-1712P
Touch screen Interface	158A	7" TouchScreen Interface	Easy operation	30XW0262-3452/S 30XW0312P-1712P
Evaporator flanged connections	314E	Victaulic to Flange water connections	Easy installation	30XW0262-3452/S 30XW0312P-1712P
Condenser flanged connections	314C	Victaulic to Flange water connections	Easy installation	30XW0262-3452/S 30XW0312P-1712P
Nitrogen charge	320	Unit nitrogen factory charged.	Less weight. No refrigerant charged	30XW0262-3452/S 30XW0312P-1712P
Discharge shut off valve	321	Allows referigerant to be stored inside the chiller during servicing	Reducing refrigerant loss and eliminating time-consuming transfer procedures	30XW0262-3452/S 30XW0312P-1712P
Australia code	312A	Meets Australia government pressure vessel code AS 1210 and AS 4343	Meets Australia government pressure vessel code AS 1210 and AS 4343	30XW0262-3452/S 30XW0312P-1712P

Options & accessories

Multi-piece shipment	51	"Side-by-side" Units only. Unit shipped in two parts bolted together, flanges on piping connections, no refrigerant charge (Nitrogen holding charge)	Easy installation	30XW1712P
Low noise	257	Provide 2 to 4 dBA sound attenuation vs std to meet low noise application * Innovative lagging used	Lower operating sound levels	30XW0262-3452/S 30XW0312P-1712P
Super low noise	258A	Provide 6 to 8 dBA sound attenuation vs std to meet super low noise application * Sound enclosure used * Waterproof, rust prevention features	Lower operating sound levels with waterproof	30XW0262-3452/S 30XW0312P-1712P
Super low noise	258C	Provide 8 to 10 dBA sound attenuation vs std to meet super low noise application * Sound enclosure used * Waterproof, rust prevention features	Lower operating sound levels	30XW0262-3452/S 30XW0312P-1712P
Soft starter	25	Provide unit soft starting, uninterrupted changeover without current peak that would stress power supply * Using a soft starter instead of Wye-Delta starter	Lower peak start-up current	30XW0262-3452/S 30XW0312P-1712P
IP44 Enclosure	20	IP44 Enclosure(Control box & Terminal box)	Higher water & rust protection level for control box & terminal box	30XW0262-3452/S 30XW0312P-1712P
Condenser CuNi tubes	841C	90/10 CuNi tubes used on condenser	Suitable for river water and sewage water	30XW0262-3452/S 30XW0312P-1712P
Evaporator CuNi tubes	841E	90/10 CuNi tubes used on evaporator	Suitable for river water and sewage water	30XW0262-3452/S 30XW0312P-1712P
Hot gas Bypass	866	Hot gas bypass minimum load down to 10%	Extend capacity operating range to match minimum load requirement	30XW/-P/-S 1261-1601
Terminal box condensation free	322	Recommended for tropical environments (hot and humid). Consist of: -Slope bottom of terminal box. -A water drain tube from the bottom of terminal box. -Thermal insulation on the surface of terminal box.	Avoid the condensation appearing on the surface of terminal box and accumulating internally. Also prevent condensation dropping on the control box where below the terminal box.	30XW0262-3452/S 30XW0312P-1712P

Notes:

1. Medium brine option PT005 is not compatible with PT150/PT150A/PT312A.
2. Low Brine options PT006 is not compatible with PT150/PT150A/PT150D/PT312A.
3. Australia code PT312A is not compatible with PT005/PT006/PT104/PT104A16/PT150/PT150A/841E/841C.
4. PT150 and PT150A is not compatible with 30XW0312P-0652P, 30XW0912P/1002P/0622/0812/0922/1762, 30XW/-P/-S 1261-1601.
5. IP44 enclosure PT020 is not compatible with PT025/PT258/PT322.
6. 30XW/-P/-S 1261-1601 are standard equipped with closed Y-delta start and not compatible with PT841C/841E.
7. Condenser water valve control option is not include 3 way valve and power supply for water valve.

Wiring Diagram

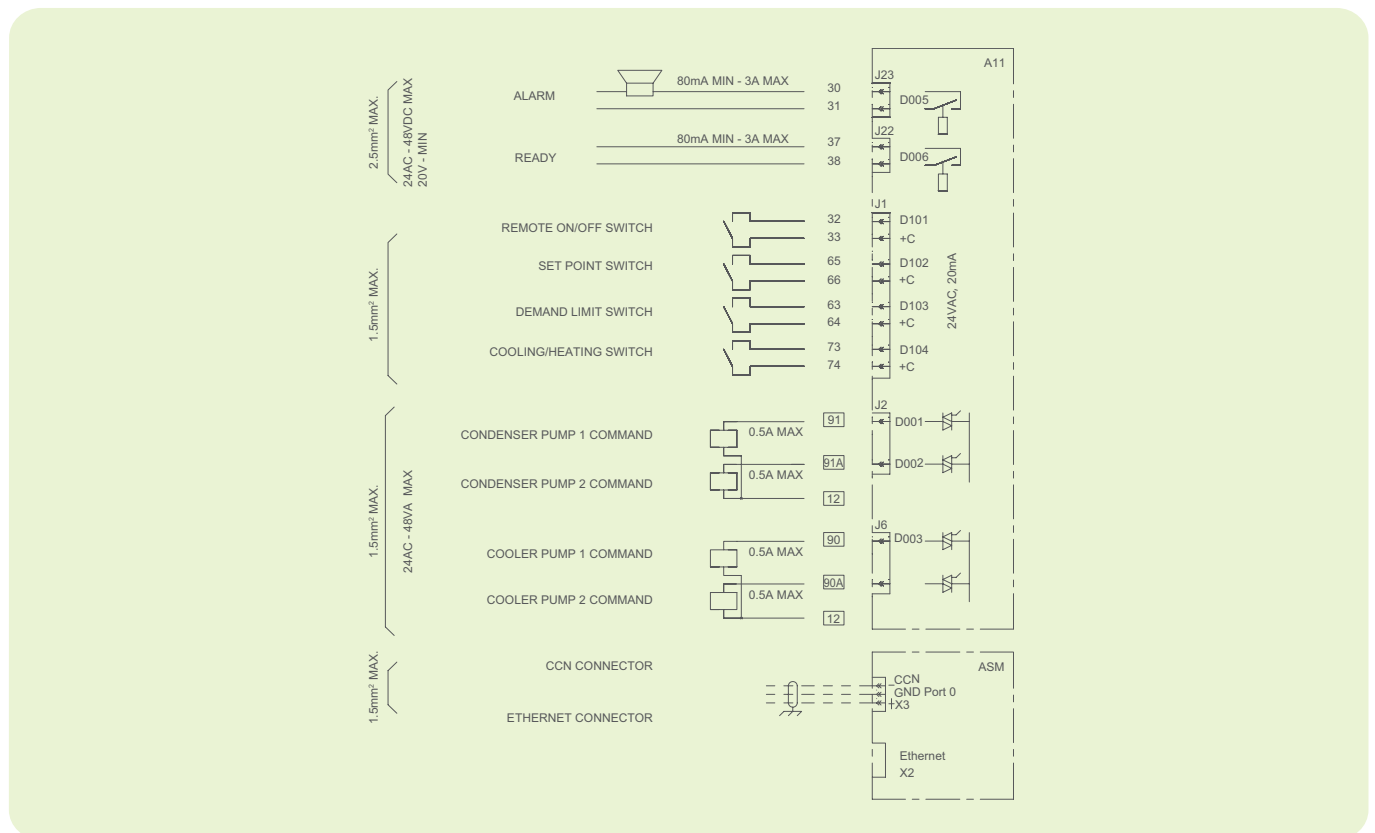

Recommendations on heat exchange fluids

Filters are required to be installed in water entering side, and water quality analysis periodically implement.

Water quality should be maintained within the limits indicated in below table.

Water Characteristics	Quality Limitation
NH ₃	<2 ppm
NH ⁴⁺	<2 ppm
Cl ₂	<1 ppm
Cl ⁻	< 300 ppm
H ₂ S*	<0.05 ppm
SO ₄ ²⁻	< 70 ppm
CO ₂ †	<5 ppm
Fe ²⁺ /Fe ³⁺	<0.2 ppm
O ₂	< 5 ppm

Water Characteristics	Quality Limitation
NO ₃	<100 ppm
Si	< 0.1 ppm
Al	<0.2 ppm
Mn	<0.1 ppm
Hardness	71.2<...<151.3mg/l CaCO ₃
Resistance	>3000ohm.cm
Conductivity	200<...<600μS/cm
Ph	7.5<...<9

System minimum water volume

Whichever the system, the water loop minimum capacity is given by the formula:

$$\text{Capacity} = \text{Cap(kW)} \times \text{N Liters}$$

Where Cap is the nominal system cooling capacity (kW) at the nominal operating conditions of the installation.

This volume is necessary for stable operation and accurate temperature control.

Application	N
Normal air conditioning	3.5
Process type cooling	6.5

It is often necessary to add a buffer water tank to the circuit in order to achieve the required volume. The tank must itself be internally baffled in order to ensure proper mixing of the liquid (water or brine). Refer to the examples below.

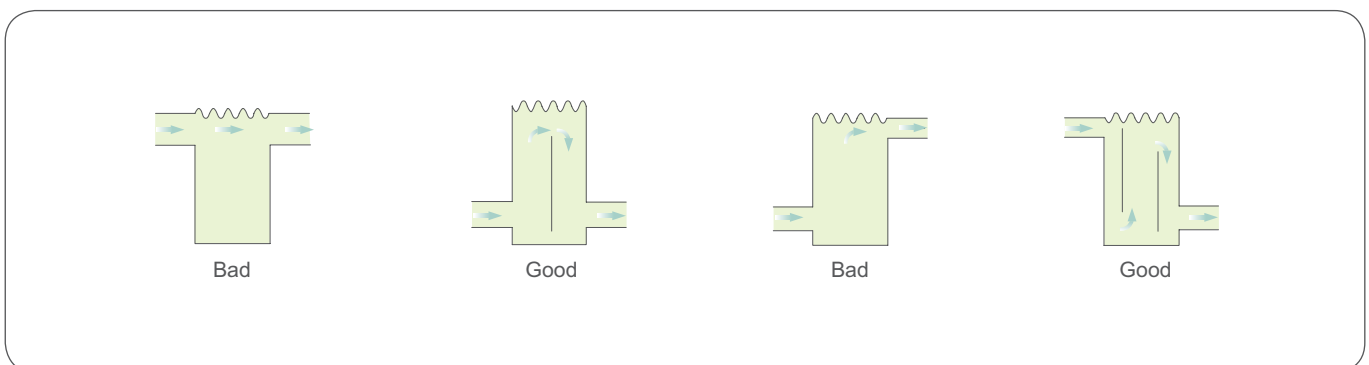

Guide Specifications

General description

Factory assembled single piece water-cooled liquid chiller. Contained within the unit shall be all factory wiring, piping, controls, refrigerant charge (HFC-134a), refrigeration circuits set, screw compressors, electronic expansion valves and equipment required prior to field start-up.

Quality assurance

1. Unit construction shall comply with standard including the following:
 - A. Code of design of heating, ventilation and air conditions (GBJ 19-87, GB50019-2003).
 - B. GB/T 18430.1-2007, AHRI Standard 550/590 and 551/591.
 - C. ISO3746-1996 and ARI575-1987.
2. Unit shall be designed, manufactured and tested in a facility with a quality management system certified ISO 9001 and environmental management system ISO 14001.
3. Unit shall be run tested at the factory.
4. Unit components shall be capable of withstanding 60°C (66°C for PT150A) storage without damage, failure, refrigerant loss, or safety risks.

Product features

1. Compressors:
 - A. Unit shall have semi-hermetic twin-screw compressors with internal relief valve and check valve to avoid reverse rotation on shut down.
 - B. Each compressor shall be equipped with a discharge shut-off valve (option).
 - C. The discharge shall also be equipped with a muffler to reduce discharge gas pulsations.
 - D. Capacity control shall be provided by a variable control slide valve capable of reducing compressor capacity down to 15% of full load. Compressor shall start in unloaded condition.
 - E. Motor shall be cooled by suction gas and protected by internal winding temperature sensors. Compressor bearings shall be designed for minimum 73000 hours at maximum operating conditions.
 - F. Lubrication oil system shall include pre-filter and external filter capable of filtration to 5 microns.
2. Evaporator:
 - A. Unit shall be equipped with a single evaporator.
 - B. Evaporator shall be manufactured, tested and stamped in accordance with the GB150-1999.
 - C. The maximum refrigerant-side working pressure will be 1500kPa (1750kPa for PT150A), and the maximum waterside pressure will be 1000kPa (1600kPa, 2100kPa as an option).
 - D. The evaporator shall be mechanically cleanable, shell-and-tube type with removable heads. Tubes shall be internally and externally grooved, seamless-copper, and shall be rolled into tube sheets. Shell shall be insulated with 19mm closed-cell foam with a maximum K factor of 0.28. Evaporator thermal insulation shall be factory fitted.
 - E. The evaporator shall have a drain and vent in each head.
 - F. The evaporator shall incorporate an active refrigerant level control system to ensure optimum heat transfer performance under all load conditions.
 - G. Design shall incorporate either 1 or 2 independent refrigerant circuits.
 - H. Chiller shall have only one water inlet & outlet connection with victaulic couplings to avoid vibrations transmission and accept small misalignment (water connection kit on demand).
 - I. Evaporator shall be fitted with electronic auto setting water flow switch. Paddle switches or differential pressure switches shall not be acceptable.
3. Condenser:
 - A. Unit shall be equipped with a single condenser.
 - B. Condenser shall be manufactured, tested and stamped in accordance with the GB150-1999.
 - C. The maximum refrigerant-side working pressure will be 1500kPa (2350kPa for PT150A), and the maximum waterside pressure will be 1000kPa (1600kPa, 2100kPa as an option).
 - D. The condenser shall be mechanically cleanable shell-and-tube type with removable heads.
 - E. Tubes shall be internally and externally grooved, seamless-copper, and shall be rolled into tube sheets.
 - F. Design shall incorporate either 1 or 2 independent refrigerant circuits and the oil separator.
 - G. The condenser shall have a drain and vent in each head.
 - H. Chiller shall have only one water inlet & outlet connection with victaulic couplings to avoid vibrations transmission and accept small misalignment (water connection kit on demand).

4. Refrigeration circuits:

- A. Refrigerant circuit components shall include, compressor, oil separator, high and low side pressure relief devices, compressor discharge (option) and liquid line shutoff valves, refrigerant economizer, filter driers, moisture indicating sight glasses, long stroke electronic expansion device, and complete operating charge of both refrigerant HFC-134a and compressor oil.
- B. To facilitate service and maintenance and avoid refrigerant charge transfers, it must be possible to isolate the following components and systems independently: filter driers, oil filters, expansion devices and compressor (with service valves option).

5. Controls:

- A. Unit controls shall include as a minimum: microprocessor with non-volatile memory, picture guided unit/operator interface, the LOCAL/OFF/REMOTE/CCN selector and a touch-screen display with with multiple language capability.
- B. Pressure sensors shall be installed to measure suction, discharge, and oil pressure.
- C. Thermistors shall be installed to measure cooler entering and leaving water temperatures (on cooler and condenser side).
- D. Unit shall be capable of performing the following functions:
 - Automatic change-over and cycling of compressors to equalize running hours and number of starts.
 - EXV control, based on throttling optimizes evaporator charging, ensuring condenser superheat and sub-cooling.
 - Capacity control based on leaving chilled fluid temperature with return fluid temperature sensing.
 - Limit the chilled fluid temperature pull-down rate at start-up to an adjustable range of 0.1°C to 1.1°C per minute to prevent excessive demand spikes at start-up.
 - Enable reset of leaving chilled water temperature according to the return water temperature or by means of a 0-10V signal.
 - Provide a dual set point for the leaving chilled water temperature activated by a remote contact closure signal or by the built in time clock.
 - Enable a 2-level demand limit control (between 0 and 100%) or a maximum current drawn limit activated by a remote contact closure or by the built in time clock.
 - Control evaporator water pump and the condenser pump.
 - Allow two time scheduling programs to enable unit start-up control, demand limit and set-point changes.
 - Enable lead lag control of two chillers running in series or parallel.

6. Diagnostics:

- A. Display module shall be capable of displaying set points, system status including temperatures, pressures, current for each compressor, run time and percent loading.
- B. The control system shall allow a quick test of all machine elements to verify the correct operation of every switch, circuit breaker, contactor etc. before the chiller is started.

7. Safeties:

- A. Unit shall be equipped with all necessary components, and in conjunction with the control system shall provide the unit with protection against the following:
 - Reverse rotation.
 - Low chilled water temperature.
 - Low oil pressure (per compressor).
 - Current imbalance.
 - Compressor thermal overload.
 - Automatic compressor unloading in case of excessive condensing temperature.
 - High pressure.
 - Electrical overload.
 - Loss of phase.
- B. Control shall provide separate general alert (minor incident) and alarm (circuit down) remote indication.

8. Operating characteristics:

- A. Unit shall be capable of starting with 13°C entering water temperature to the condenser.
- B. Unit shall be capable of starting with 35°C entering water temperature to the evaporator.

9. Electrical characteristics:

- A. Unit shall operate on 3-phase power supply without neutral.
- B. Control voltage shall be supplied by a factory-installed transformer.
- C. Unit shall be supplied with factory-installed electrical disconnect/isolator switch integrating main fuses.
- D. Unit shall have a factory installed star/delta starter as standard to limit electrical inrush current.



Carrier improves the world around us; Carrier improves people's lives; our products and services improve building performance; our culture of improvement will not allow us to rest when it comes to the environment.



Version:	CAT_30XW_E-1911_13
Supersedes:	CAT_30XW_E-1709_12
Effective date:	Oct, 2019